

SIGNAL LIGHTS SET SAL PP M0200

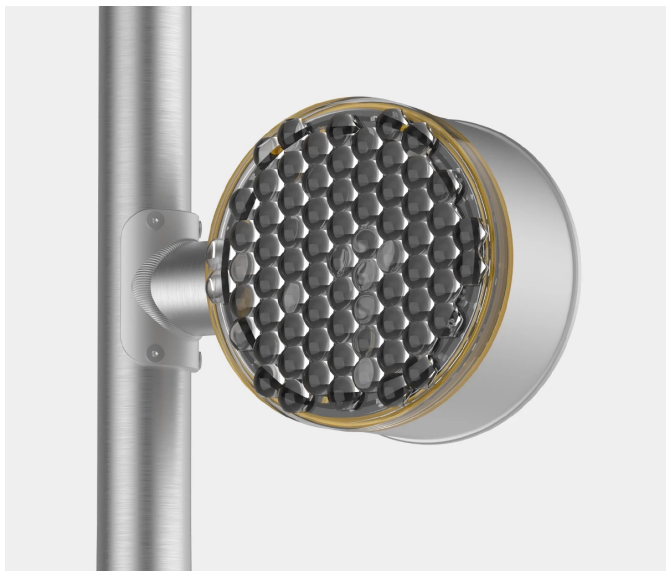

TECHNICAL DATA

Application	pedestrian crossings
Assembly	A - for mounting on a column with a diameter of $\varnothing 60$; B - universal handle for mounting on a column with a diameter of $\varnothing 76-100$
Ingress protection	IP 65
Material	anodised aluminium alloy
Operating temperature range	from -30°C to $+55^{\circ}\text{C}$
Communication	Wireless communication 2,4 GHz, range to 300 m
Programmable activation time of the flashing light	10, 13, 16, 19, 22, 25, 28, 31, 34, 37s
Dimensions	205 x 140 x 287 mm
Battery energy storage	cells LiFePO ₄ , 12,8V 2,5Ah 32Wh
Maximum electric power	30 W
Built-in battery charging power	15 W
	-



TABLE OF TYPES

Code	Symbol	Battery type	Number of lamps	Handle type	Net weight
219901/A/C...	Signal lights set SAL PP M0200	-	1	A	4.2 kg
219901/B/C...	Signal lights set SAL PP M0200	-	1	B	4.5 kg
219902/A/C...	Signal lights set SAL 2xPP M0200	-	2	A	8.4 kg
219902/B/C...	Signal lights set SAL 2xPP M0200	-	2	B	9 kg
219904/A/C...	Signal lights set SAL 4xPP M0200	-	4	A	12.6 kg
219904/B/C...	Signal lights set SAL 4xPP M0200	-	4	B	13.5 kg
219801/A/C...	Signal lights set SAL PP M0200 AKU	LiFePO 32 Wh	1	A	4.5 kg
219801/B/C...	Signal lights set SAL PP M0200 AKU	LiFePO 32 Wh	1	B	4.8 kg
219802/A/C...	Signal lights set SAL 2xPP M0200 AKU	LiFePO 32 Wh	2	A	9 kg
219802/B/C...	Signal lights set SAL 2xPP M0200 AKU	LiFePO 32 Wh	2	B	9.6 kg
219804/A/C...	Signal lights set SAL 4xPP M0200 AKU	LiFePO 32 Wh	4	A	13.5 kg
219804/B/C...	Signal lights set SAL 4xPP M0200 AKU	LiFePO 32 Wh	4	B	14.4 kg

C... - selected anodizing colour

SYSTEM DESCRIPTION

The signaling lamp is designed to be installed at pedestrian crossings. The blinking lamp warns vehicle drivers about the presence of pedestrians in the crossing. Activation can take place via a button installed on the column, or by means of a motion sensor detecting the presence of pedestrians. All lamps assigned to the same group, i.e. located on the same doorway, are switched on. Control within one passage is carried out based on wireless communication - thus eliminating the need to connect the systems on different sides of the road with control wires. Thanks to the use of a buffer power supply system with a battery energy storage, the system works around the clock also in circuits where the power is disconnected during the day - the buffer power supply system at night collects energy that is used during the day.

SYSTEM OPERATING MODES

Night mode

The Safe Crosswalk Lighting System is powered from the AC network. Activating the button by a pedestrian turns on the warning lamps for a specified period of time and increases the lighting power of street luminaires equipped with the "Line Switch" function. In night mode, the battery is charged and powers the system in day mode

Day mode

The AC power source is turned off. The Safe Crosswalk Lighting System is powered by a rechargeable battery. Activating the button by a pedestrian turns on the warning lamps for a specified period of time. The power buffer circuit becomes disconnected when the packet voltage reaches the configured trip threshold.

SIGNAL LIGHTS SET SAL PP M0200

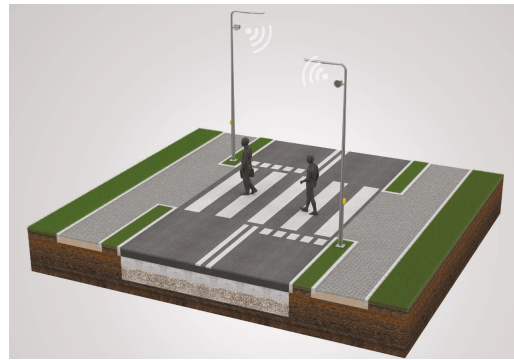
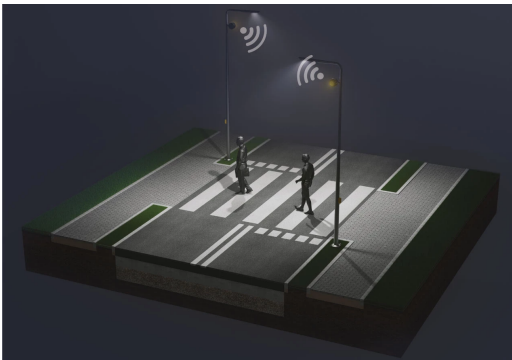

COMPARISON OF PEDESTRIAN CROSSINGS BEFORE AND AFTER MODERNIZATION.

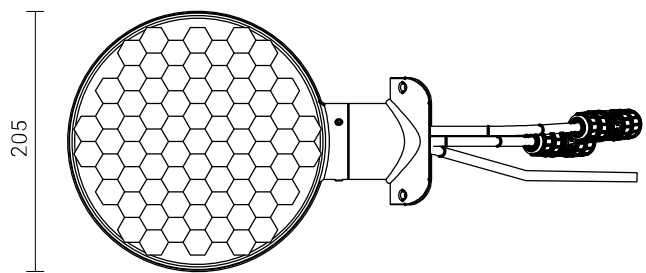
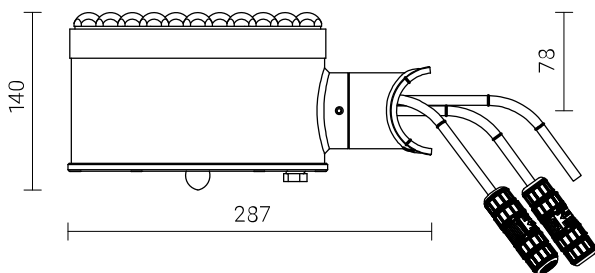
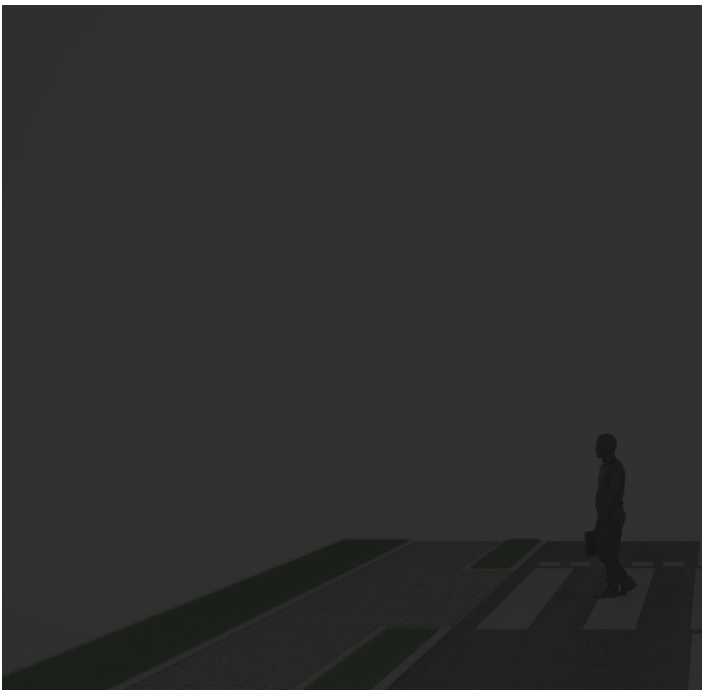

In a typical version of the product, the cable lengths are as follows: power cord 5m; signal cable for pedestrian button 5 m; 2.5m lamp power cord. The standard lengths allow the system to be mounted on the SAL DL -10 pole. If it is necessary to use cables of a different length, please contact the Sales Department of the ROSA company.

THE MOUNTING ELEMENT OF THE SET IS THE A OR B HANDLE (DEPENDING ON THE TYPE OF COLUMN):

Handle A
a handle for mounting on a column with a diameter of $\varnothing 60$ using screws ST6,3x19
(recommended installation on the SAL DL-10 column)

Handle B
universal handle for mounting on a column with a diameter of $\varnothing 76-100$ with the use of clamps

SIGNAL LIGHTS SET SAL PP M0200

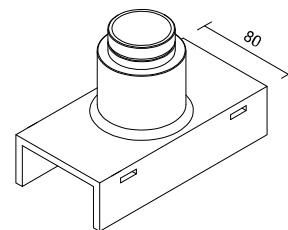
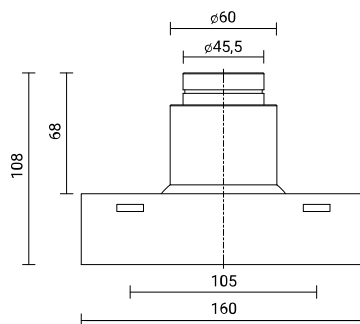
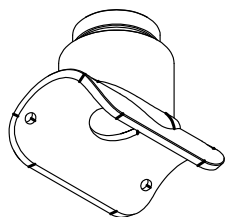
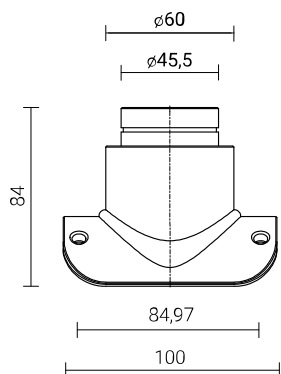

DIRECTIVES: 2014/35/UE
STANDARDS: EN 12352:2010

RELATED PRODUCTS:



ISKRA LED P PROG
Code: 21320132/LS
(LineSwitch version)



SAL DL-10
Code: 42999/C45/C35

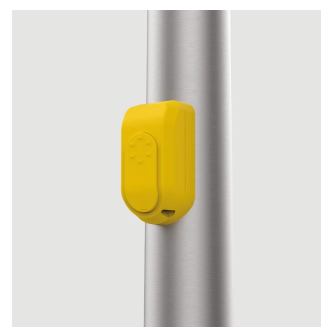

Signal requesting device Easyguide
Code: 219700