

Aluminium extension arms WR-14/2/1,0/5

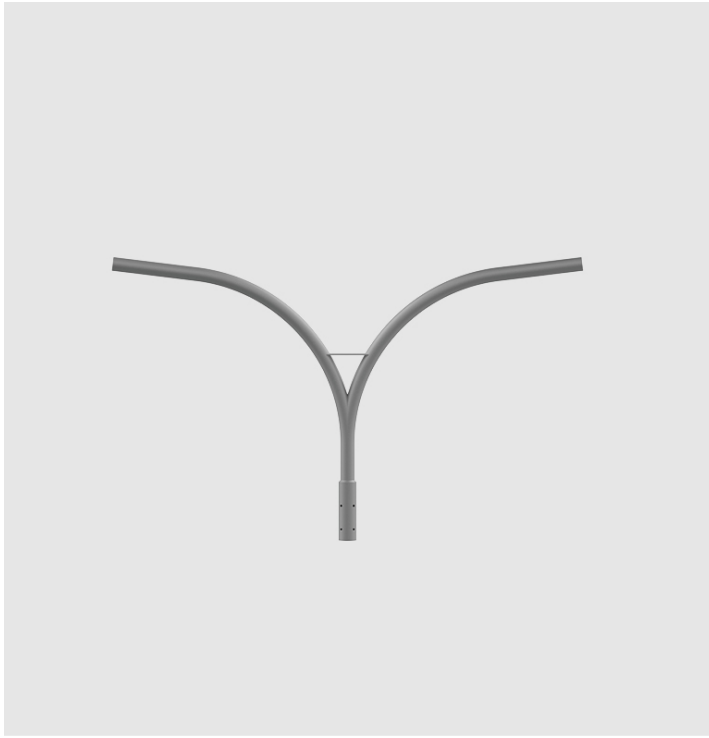

Anodising: 10 colours, each with possibility of chemical brightening

Finish: grinded, anodised aluminium

Packing: sleeve material

CE: the extension arm with the pole make a set - for extension arms, the Declaration of Performance applies to the pole on which extension arms is mounted.

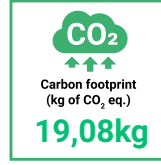

Code	Symbol	Purpose	Number of arms	Extension arm effective projected area	Approximate unit volume	Luminaire mounting diameter	Weight
472142	WR-14/2/1,0/5	—	2	0,191m ²	0,1m ³	ø60mm	5,7kg

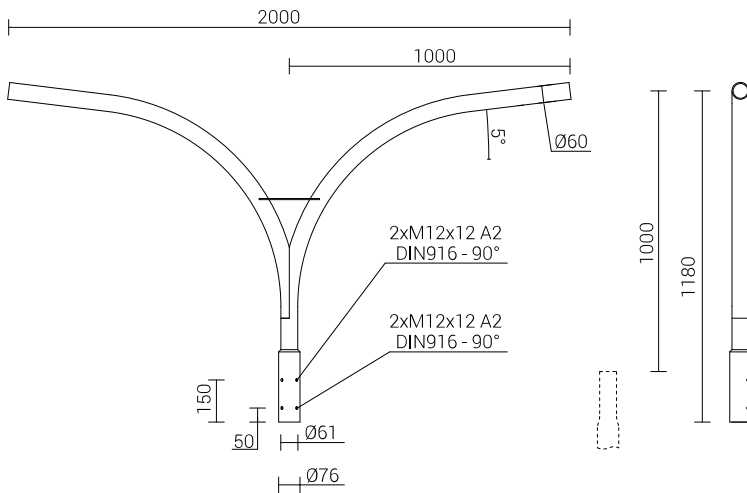

Cradle to Cradle Certified® is a registered trademark of the Cradle to Cradle Products Innovation Institute.